

4

3

2

1

RoHS REACH compliant

REVISION DATA				
SYM	REV	DESCRIPTION	DATE	APPR.
	00	new part	03.08.17	MR

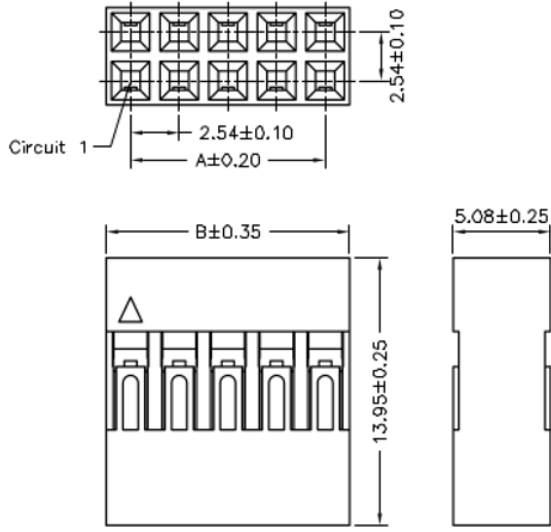

Technical Specification

Current Rating: 3A AC, DC
Voltage Rating: 250V AC,DC
Temperature: -25°C to +85°C
high temperature: on request
Contact Resistance: 20mΩ
Insulation Resistance: 1000MΩ
Withstanding Voltage: 1500V AC/minute
Material: Thermoplastic, UL94V-0

Circuit No.	Dimensions		Circuit No.	Dimensions	
	A	B		A	B
2X02P	2.54	5.08	2X22P	53.34	55.88
2X03P	5.08	7.62	2X23P	55.88	58.42
2X04P	7.62	10.16	2X24P	58.42	60.96
2X05P	10.16	12.70	2X25P	60.96	63.50
2X06P	12.70	15.24	2X26P	63.50	66.04
2X07P	15.24	17.78	2X27P	66.04	68.58
2X08P	17.78	20.32	2X28P	68.58	71.12
2X09P	20.32	22.86	2X29P	71.12	73.66
2X10P	22.86	25.40	2X30P	73.66	76.20
2X11P	25.40	27.94	2X31P	76.20	78.74
2X12P	27.94	30.48	2X32P	78.74	81.28
2X13P	30.48	33.02	2X33P	81.28	83.82
2X14P	33.02	35.56	2X34P	83.82	86.36
2X15P	35.56	38.10	2X35P	86.36	88.90
2X16P	38.10	40.64	2X36P	88.90	91.44
2X17P	40.64	43.18	2X37P	91.44	93.98
2X18P	43.18	45.72	2X38P	93.98	96.52
2X19P	45.72	48.26	2X39P	96.52	99.06
2X20P	48.26	50.80	2X40P	99.06	101.60
2X21P	50.80	53.34			

order information

D254404	xx	xx	xx	xx
No. of Positions	Special	Packaging	Special Customer	
04~80	Z6=without nose	A= bag	xx= on request	
xx= on request		xx= on request		

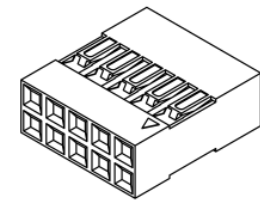

BRCONNECTORS

**Dual Row Housing
Straight Type**

<p><u>Tolerance:</u> .X ± 0.25 .XX ± 0.15 .XXX ± 0.05</p>	PROJECTON				
	DATE	03.08.2017	Customer Drawing- No.:		
	DRAWN	MR	Drawing- No.: 2161382		
	CHECKED	BR			
	APPROVED	BR	UNIT:	SCALE:	SIZE:
		mm		A4	

4

3

2

1

RoHS REACH compliant

REVISION DATA				
SYM	REV	DESCRIPTION	DATE	APPR.
	00	new part	03.08.17	MR

Technical Specification

Current Rating: 3A AC,DC
Voltage Rating: 250V AC,DC
Temperature: -25°C to +85°C
high temperature: -40°C to +105°C
Contact Resistance: 20mΩ
Insulation Resistance: 1000MΩ
Withstanding Voltage: 1500V AC/minute
Type: AWG #22 to #26, O.D.: 1.63mm (max)
Material: Phosphor Bronze /Brass

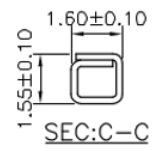
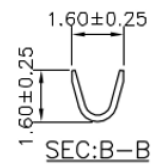
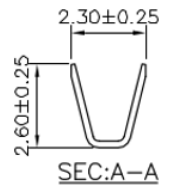
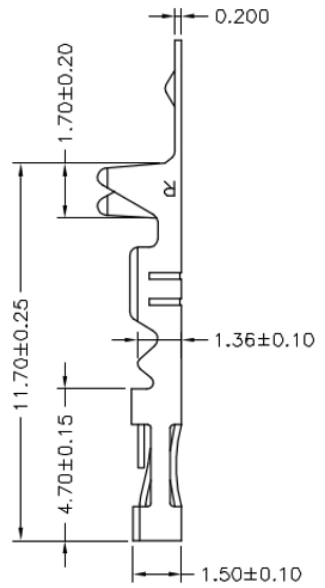
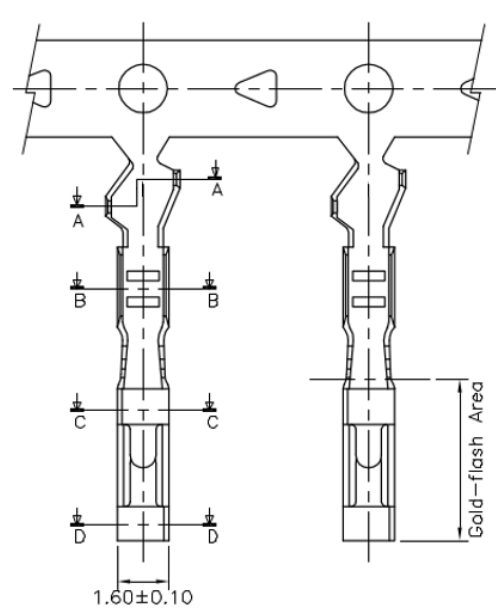

Gold-flash Area

order information

E254404	xx	xx	xx
Plating Option	Packaging	Special Customer	
01= gold flash	D= tape&reel	xx= on request	
100= tin	xx= on request		
xx= on request			



Terminal Crimp

Tolerance: .X ± 0.25 .XX ± 0.15 .XXX ± 0.05	PROJECTON				
	DATE	03.08.2017	Customer Drawing-No.:		
	DRAWN	MR	Drawing-No.: 2161384		
	CHECKED	BR			
	APPROVED	BR	UNIT:	SCALE:	SIZE: A4