

4

3

2

1

RoHS REACH compliant

REVISION DATA				
SYM	REV	DESCRIPTION	DATE	APPR.
	00	new part	03.08.17	MR

Technical Specification

Current Rating: 7A AC, DC
 Voltage Rating: 250V AC,DC
 Temperature: -25°C to +85°C
high temperature: -40°C to +105°C
 Contact Resistance: 10mΩ
 Insulation Resistance: 1000MΩ
 Withstanding Voltage: 1500V AC/minute
 Material Pin: Brass
 Material: Thermoplastic, UL94V-0

Circuit No.	Dimensions		Circuit No.	Dimensions	
	A	B		A	B
02P	3.96	7.92	12P	43.56	47.52
03P	7.92	11.88	13P	47.52	51.48
04P	11.88	15.84	14P	51.48	55.44
05P	15.84	19.80	15P	55.44	59.40
06P	19.80	23.76	16P	59.40	63.36
07P	23.76	27.72	17P	63.36	67.32
08P	27.72	31.68	18P	67.32	71.28
09P	31.68	35.64	19P	71.28	75.24
10P	35.64	39.60	20P	75.24	79.20
11P	39.60	43.56			

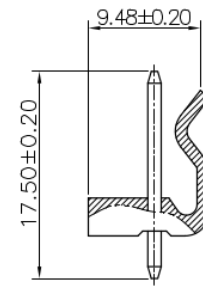
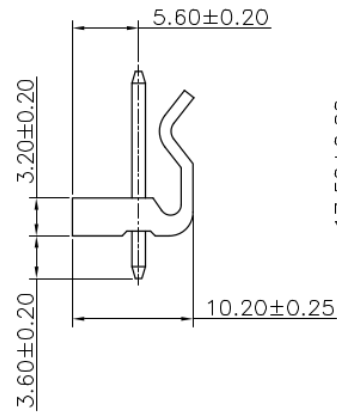
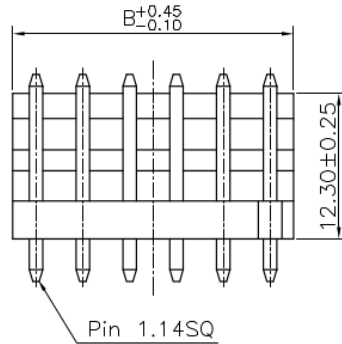
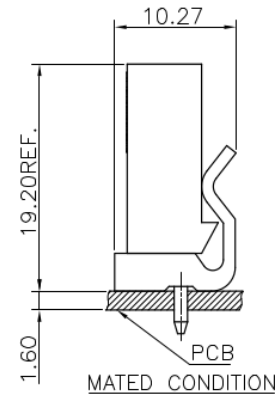
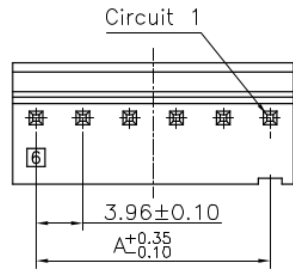

order information

C396401	xx	xx	xx	xx	xx
No. of Positions	Plating Option	Entry	Packaging	Special Customer	
02~20	01= gold flash	B1= top	A= bag	xx= on request	
xx= on request	100= tin		xx= on request		
			xx= on request		

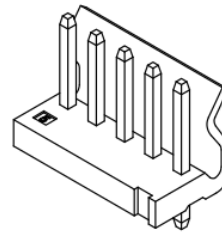
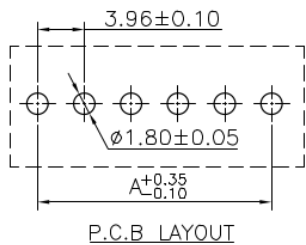

BRCONNECTORS

Single Row Wafer
THT Type, Top Entry

Tolerance: .X ± 0.25 .XX ± 0.15 .XXX ± 0.05	PROJECTON				
	DATE	03.08.2017	Customer Drawing- No.:		
	DRAWN	MR	Drawing- No.: 2161388		
	CHECKED	BR			
APPROVED	BR		UNIT: mm	SCALE:	SIZE: A4